

CONFIDENTIAL NOTICE: This drawing and the design, specifications and engineering data disclosed herein are the property of Eberhard Manufacturing Company and are not to be disseminated or otherwise copied without written consent. The drawing is issued in confidence and may only be considered for the user's exclusive use. In accordance with the drawing, no part shall be made or used for any purpose other than that for which it was intended. Eberhard Manufacturing Company, 44149 Lorain Road, Lorain, OH 44130-9912, U.S.A. © 2014 EBERHARD MFG. CO.

| REV | DESCRIPTION | EN | DATE | ISSUED BY | APPROVED BY |
|-----|-----------------------|----|------|-----------|-------------|
| 1 | ISSUED FOR PRODUCTION | | | | |

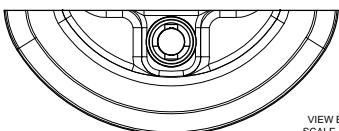
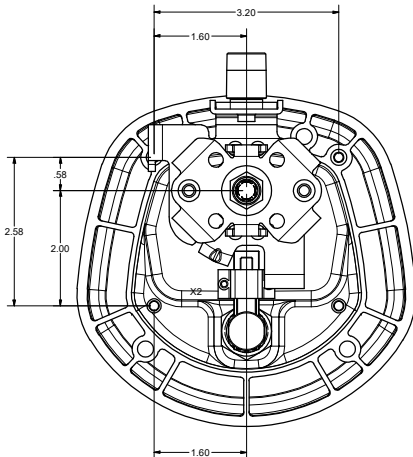
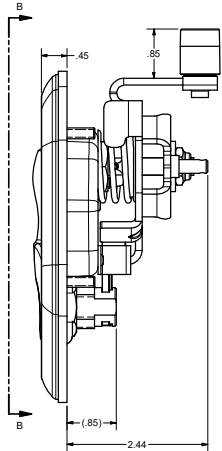
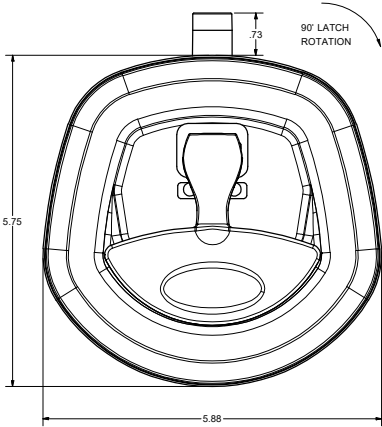
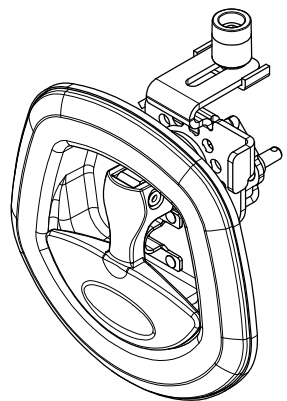
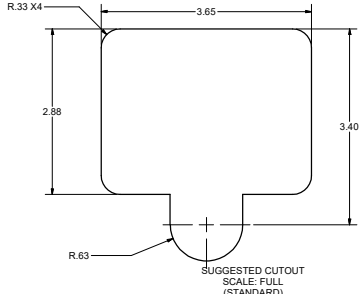
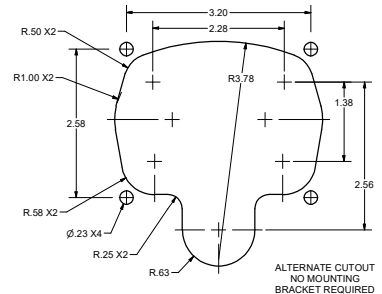
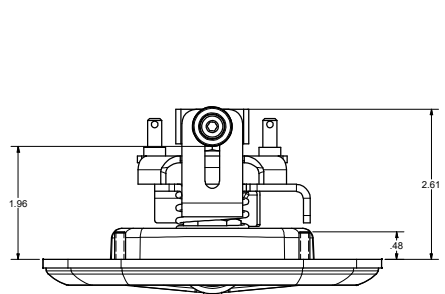

VIEW B-B
SCALE 1 : 1

COMPRESSION LATCH ASSEMBLY
LESS DOUBLE BITTED CYLINDER PLUG

- NOTES:
 1. EBERHARD FINISH CODE:
 A. (35) BLACK POWDER (TEXTURED) RECEPTACLE AND CHROME HANDLE
 2. 35 IN.-LBS MAX. TORQUE ON MOUNTING STUDS
 3. KEY CYLINDER TO BE ORDERED SEPARATELY, J201 THRU J225 & J236
 SUPPLIED WITH ONE DOUBLE BITTED KEY.
 EXAMPLE ORDER AS: XXX-2-9010DB-5-09

KEY NUMBER

4. FOR KEY CYLINDER INSTALLATION SEE DRAWING NUMBER: 1-9010DB-61P5

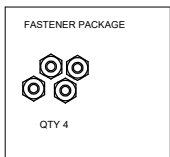

ORDER PART NUMBER
P3-28430-54-PKRL-35

CUSTOMER PRINT
SHEET 1 OF 2

RIGHT HAND SHOWN
LEFT HAND OPPOSITE

EBERHARD MANUFACTURING CO.
 DIVISION OF
 THE EASTERN COMPANY
 CLEVELAND, OHIO 44149-9712

**KEY LOCKING / PADLOCKABLE
 COMPRESSION LATCH - LESS
 CYLINDER PLUG**

P3-28430-54-PKRL

| PATTERNED | |
|--|-------------|
| THIS DOCUMENT IS IN CONFORMANCE WITH ASME Y14.2-2003 | DATE |
| DATE OF ORIGINAL PUBLICATION | 1/16/2010 |
| DATE OF THIS REVISION | 08/2014 |
| REVISION | REVISED |
| ANGLES | 25 15 |
| SPACE DEC. | 4 50 4 36 |
| SPACE DEC. | 4 815 4 38 |
| ALL DIMS. | 1 100 1 100 |

C:\Working_Folder\ehw\p3\28430\p3-28430-54-PKRL SH1.dwg